

Mo Leabhrán

Aibítire

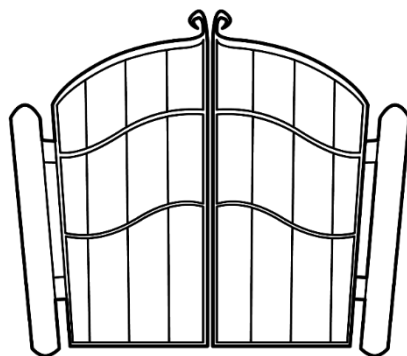
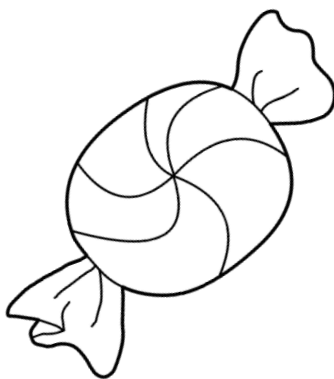
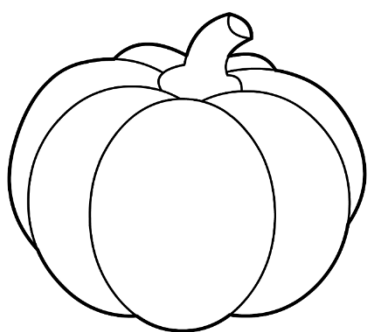

**Ainm:**

# d

Dathaigh na pictiúir,  
scríobh na focail

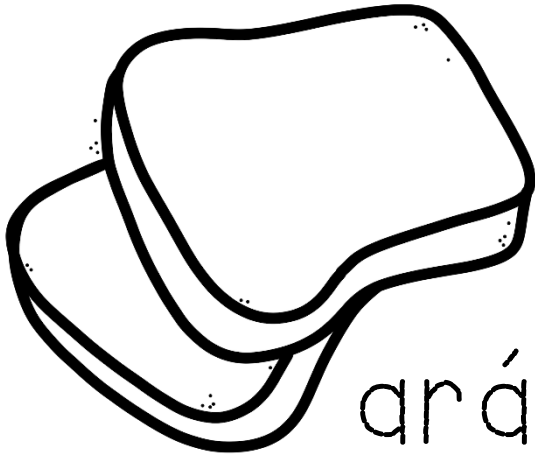

arán

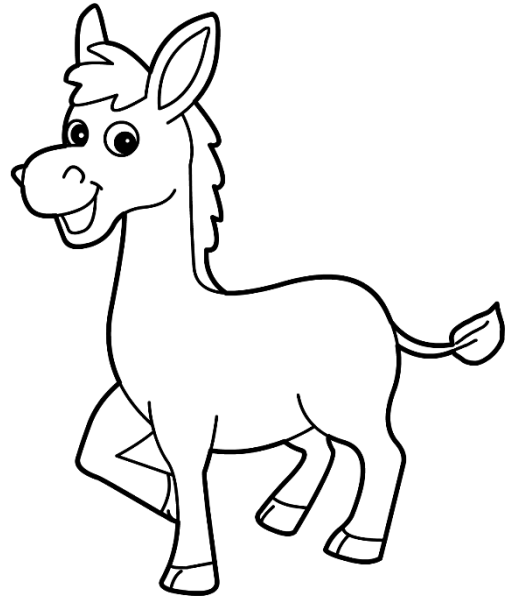

asal



altra



aingeal

d

Dathaigh na pictiúir,  
scríobh na focail

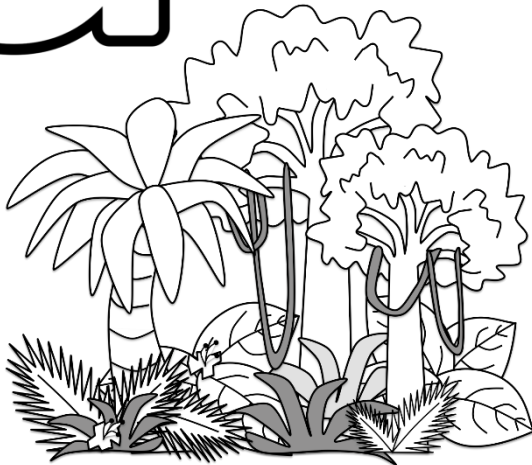

álainn

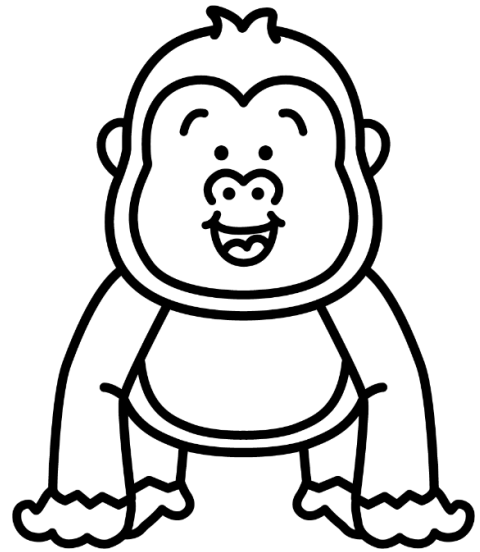

ápa

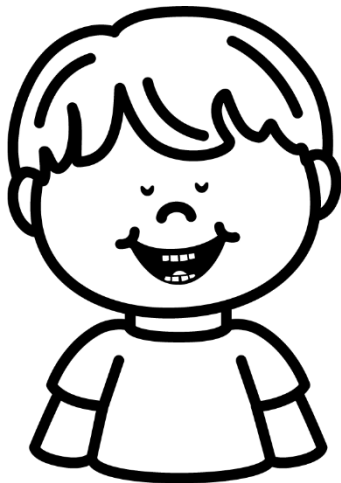

áthas

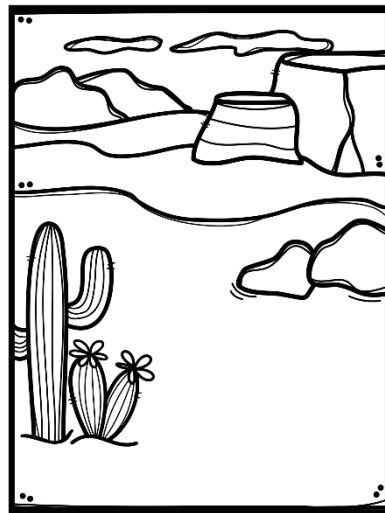

áit

# b

Dathaigh na pictiúir,  
scríobh na focail

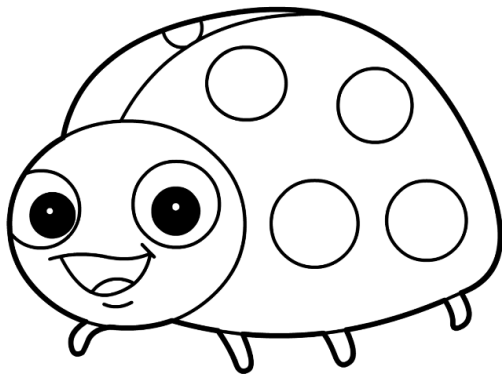

bóin Dé

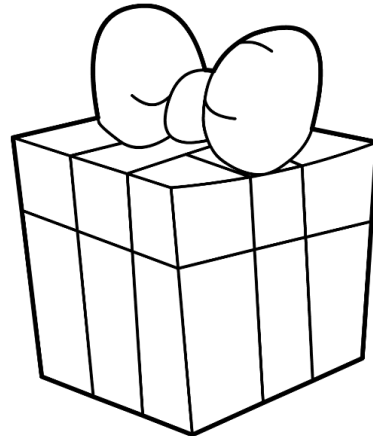

bronntanas

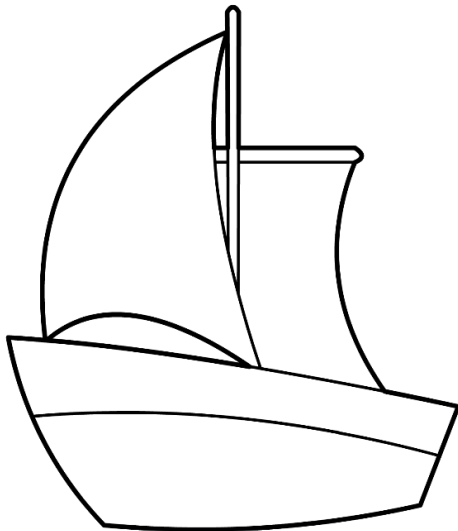

bád

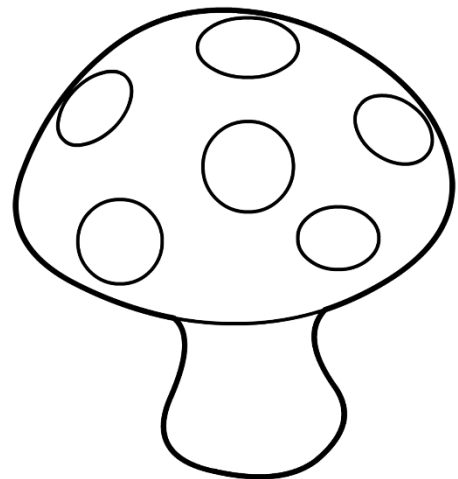

beacán

# C

Dathaigh na pictiúir,  
scríobh na focail

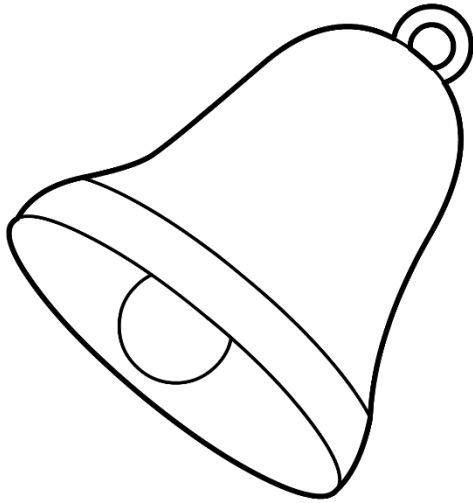

clog

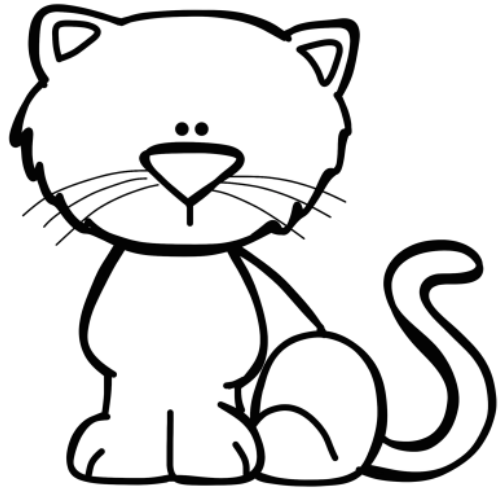

cat

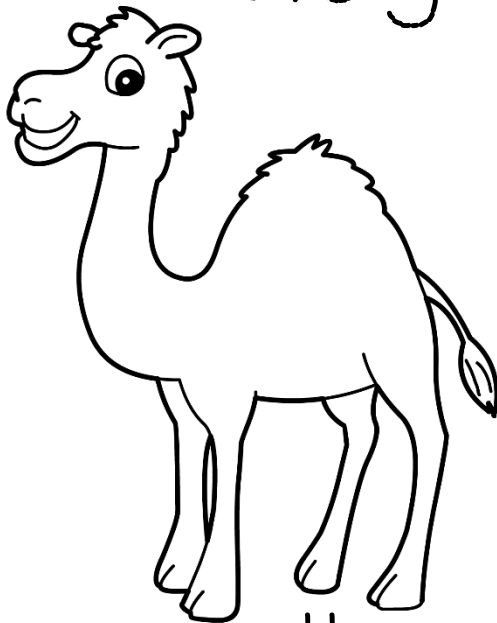

camall



cáca

d

Dathaigh na pictiúir,  
scríobh na focail



dúch

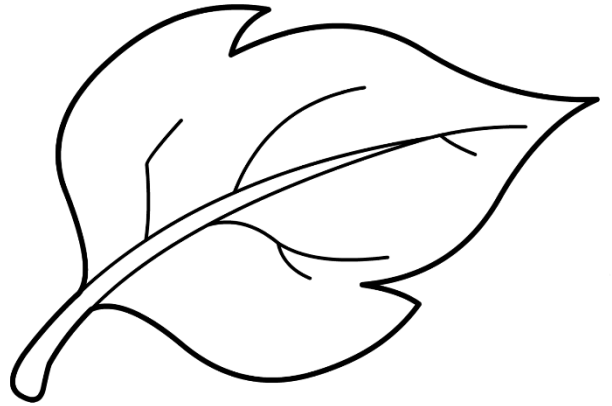

duilleog

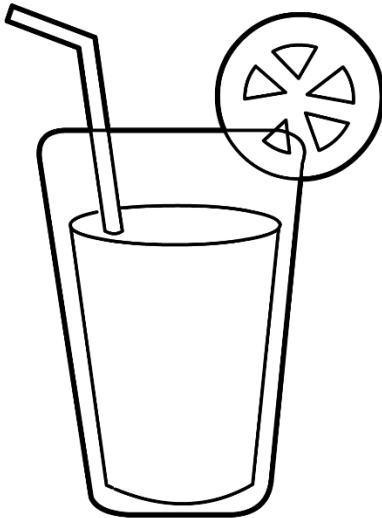

deoch

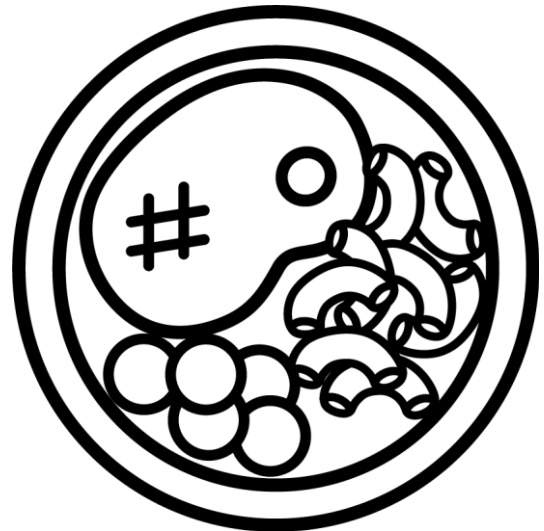

dinnéar

# e

Dathaigh na pictiúir,  
scríobh na focail

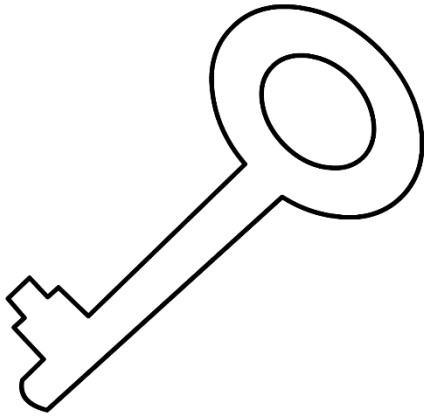

eochair

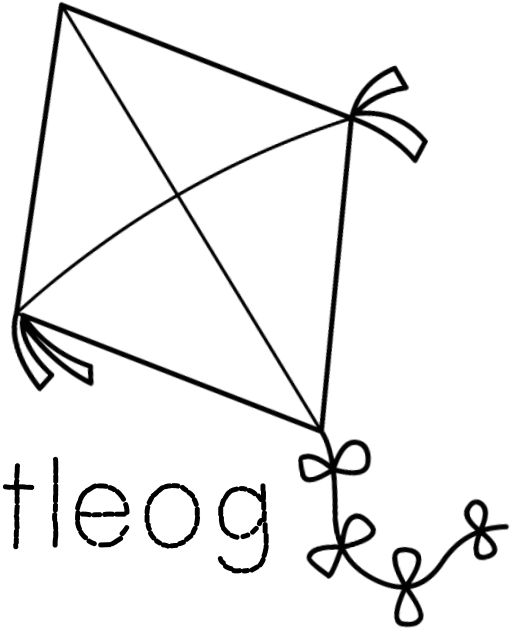

eitleog



eitleán

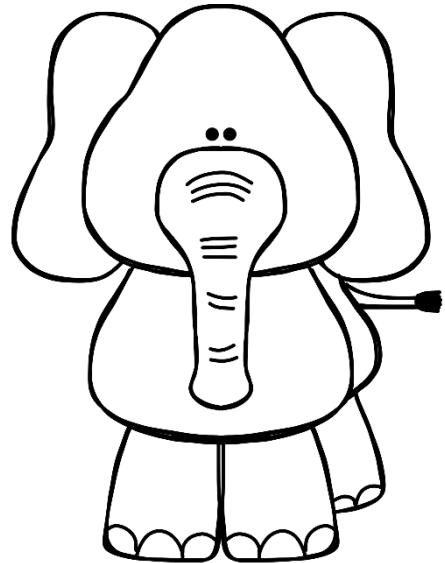

eilifint

Dathaigh na pictiúir,  
scríobh na focail

e

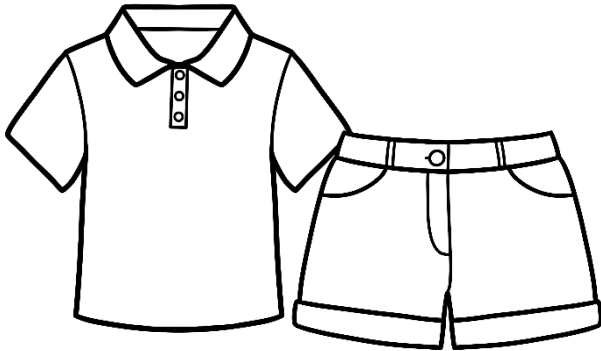

éadaí



éadrom

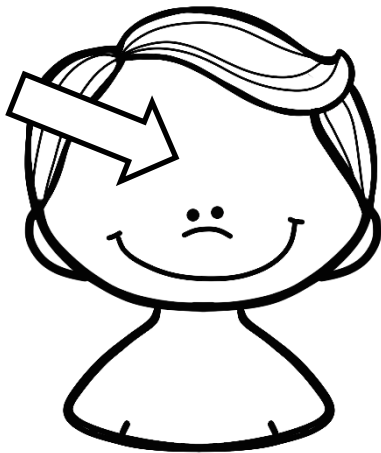

éadan

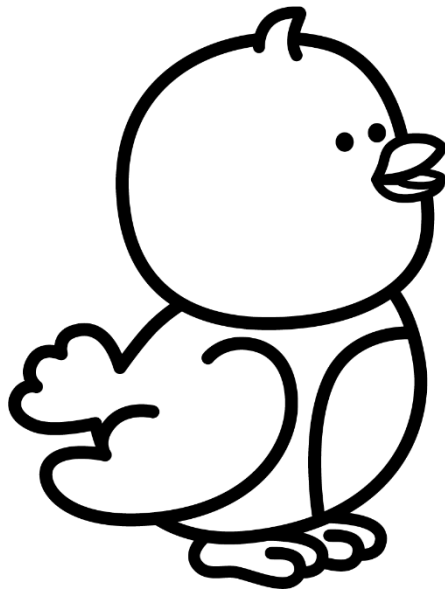

éan



f

Dathaigh na pictiúir,  
scríobh na focail

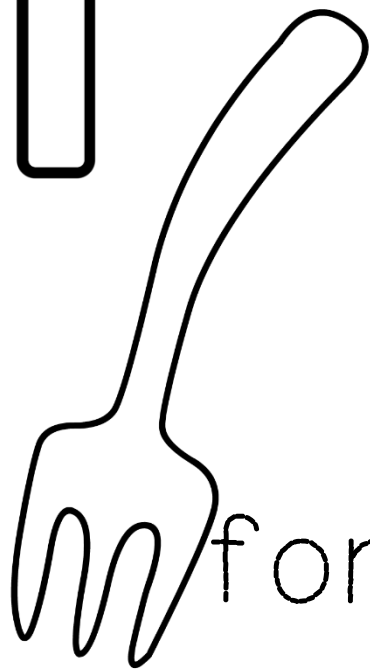

forc

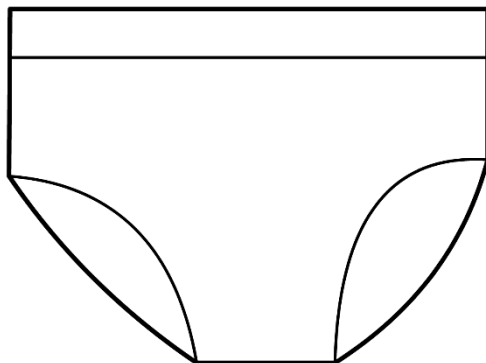

fo-éadaí

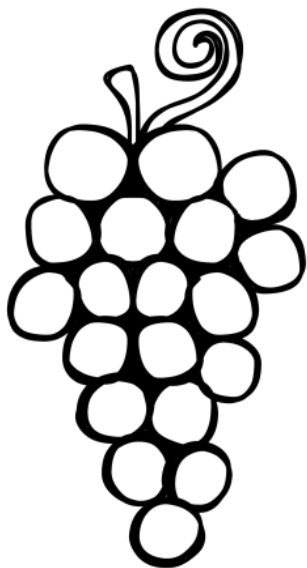

fíonchaora

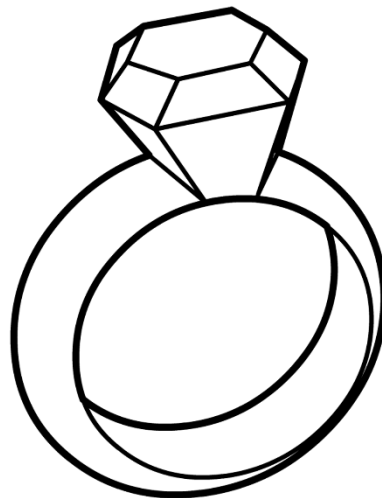

fáinne

g

Dathaigh na pictiúir,  
scríobh na focail

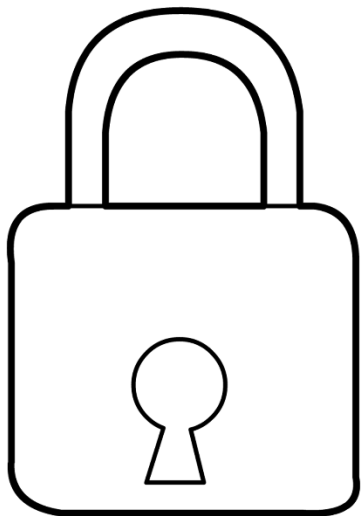

glas



gabhar

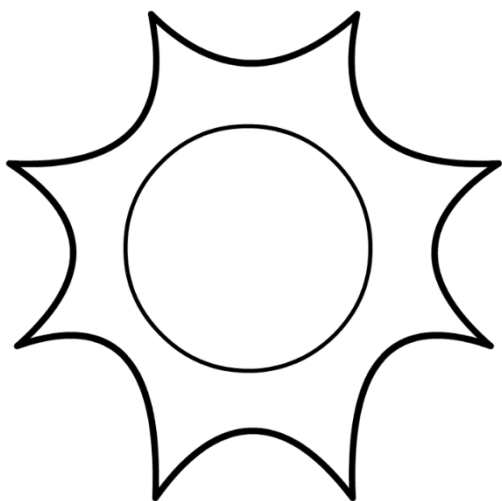

grian

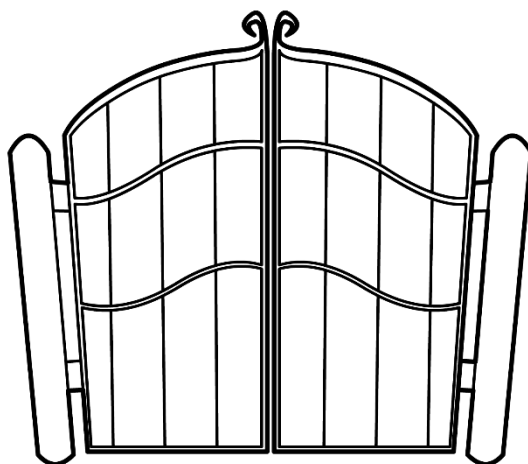

geata

# h

Dathaigh na pictiúir,  
scríobh na focail

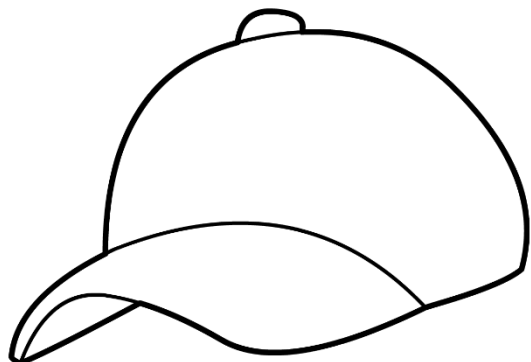

hata

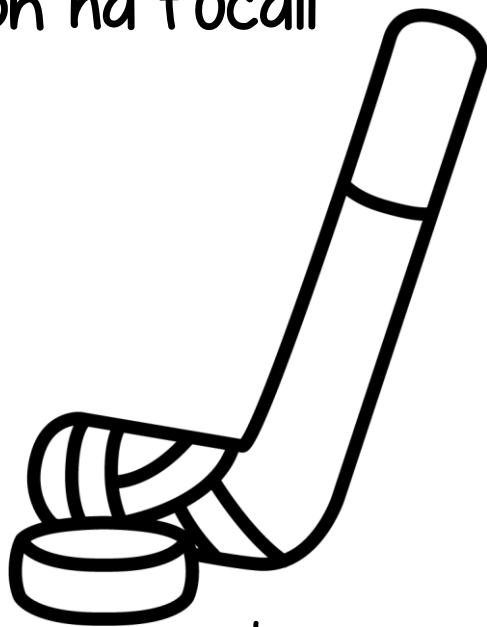

haca

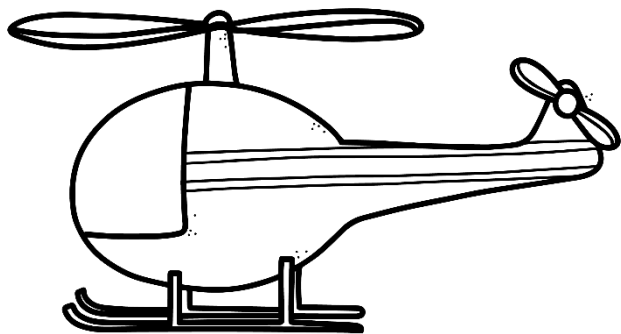

héileacaptar

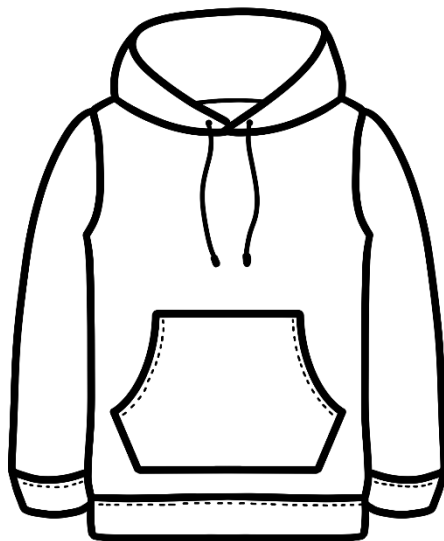

húdaí

i

Dathaigh na pictiúir,  
scríobh na focail

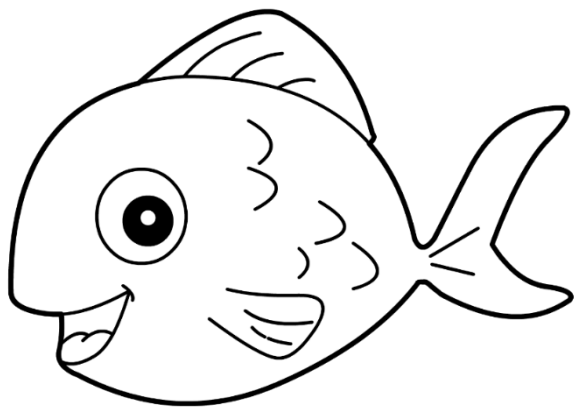

iasc

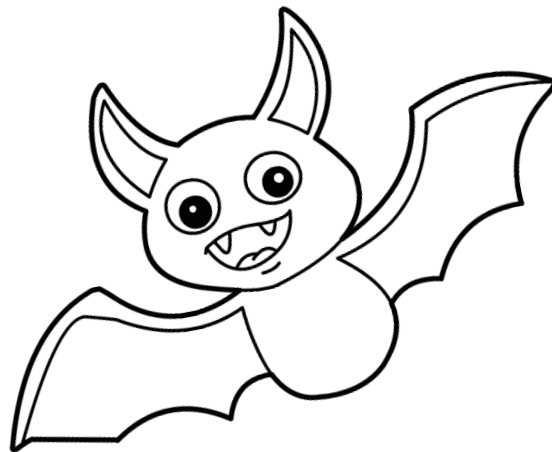

ialtóg



ióga



iógart

Dathaigh na pictiúir,  
scríobh na focail

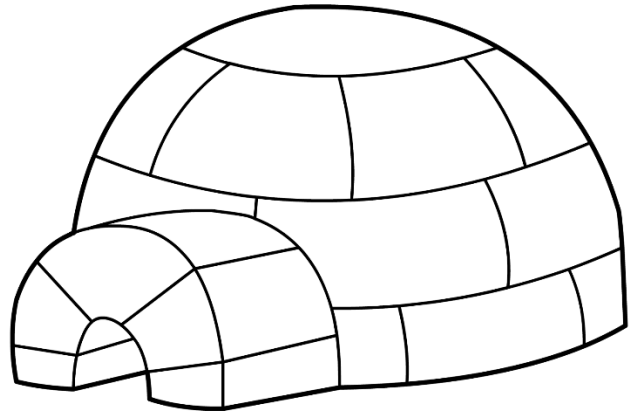
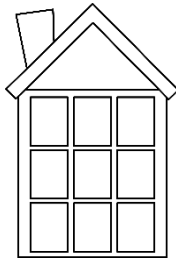
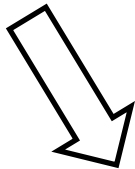
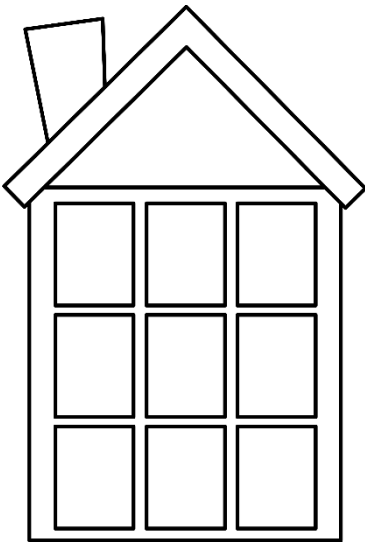

íoghlú

íseal

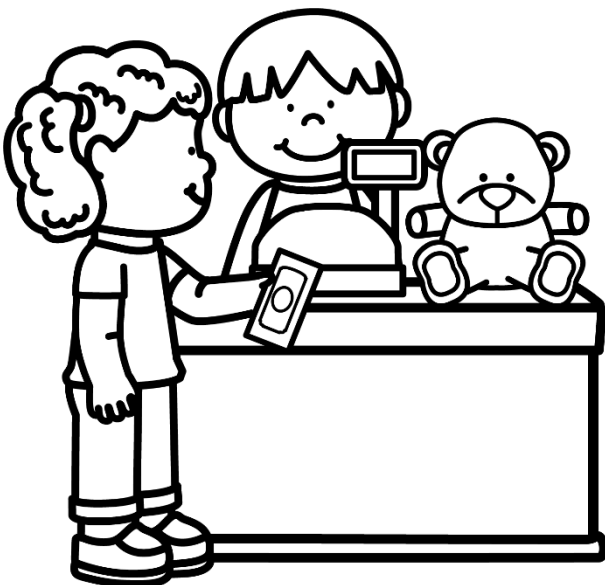

íoc

j

Dathaigh na pictiúir,  
scríobh na focail



jacáí

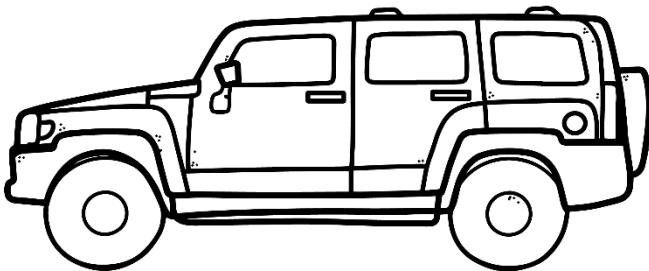

jíp



júdó

Dathaigh na pictiúir,  
scríobh na focail

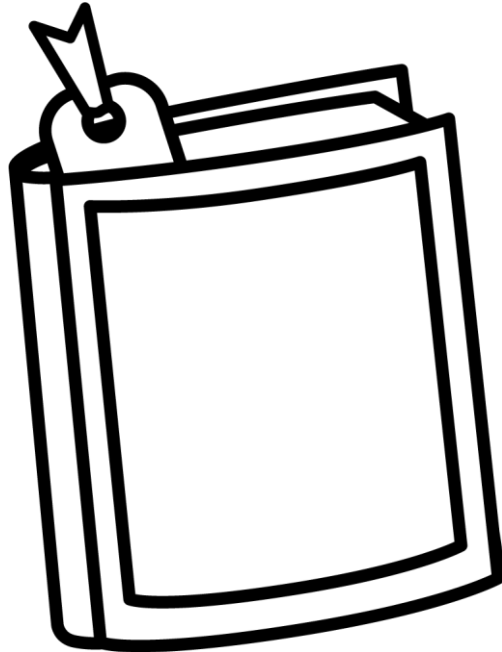

leabhar



luch

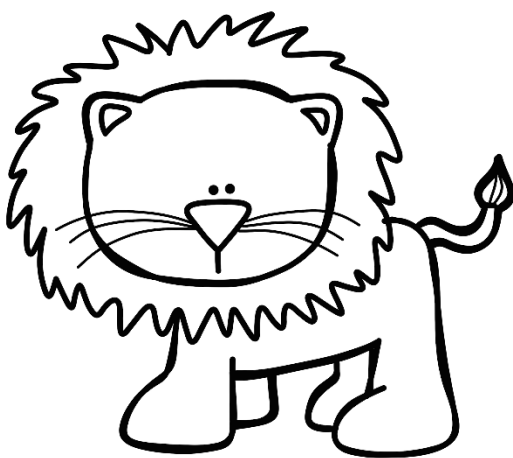

leon

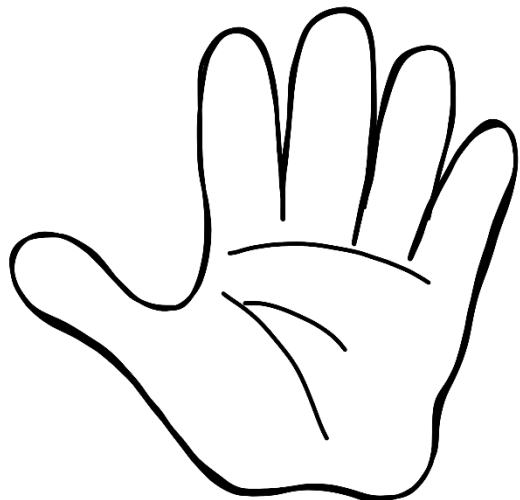

lámh

# m

Dathaigh na pictiúir,  
scríobh na focail

mapa

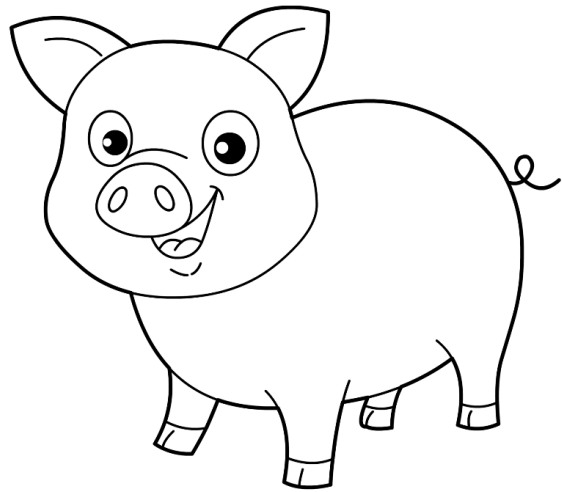
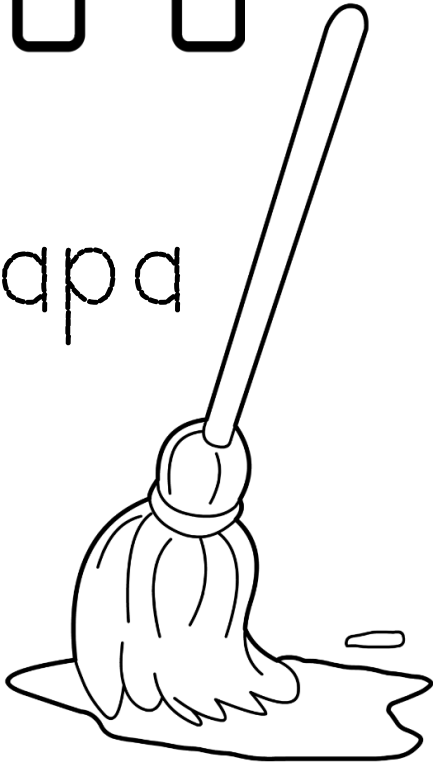

muc

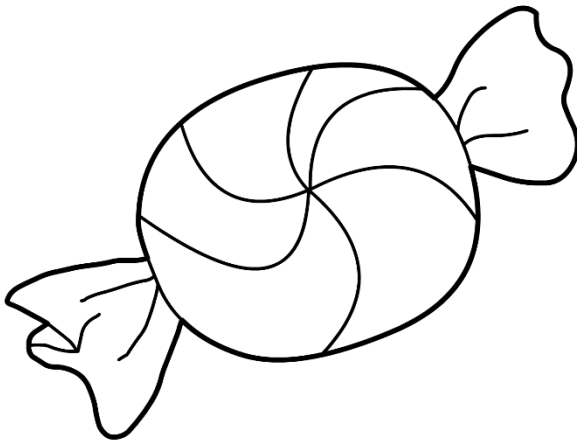

milseán

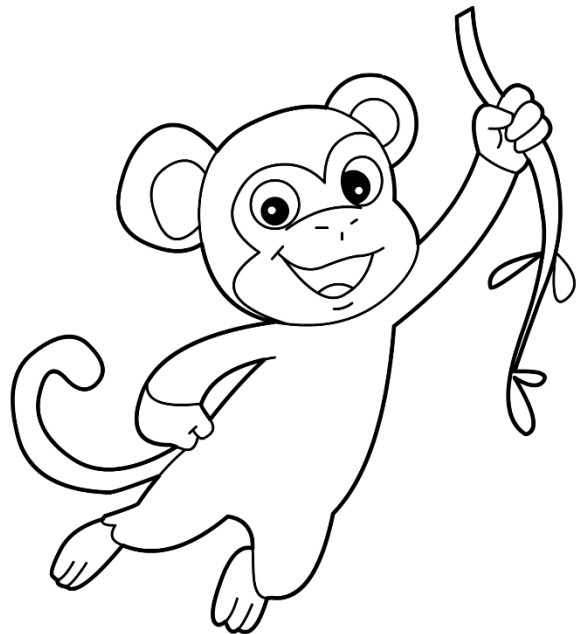

moncaí



# n

Dathaigh na pictiúir,  
scríobh na focail

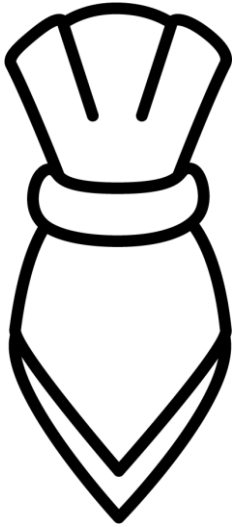

naipcín



nead

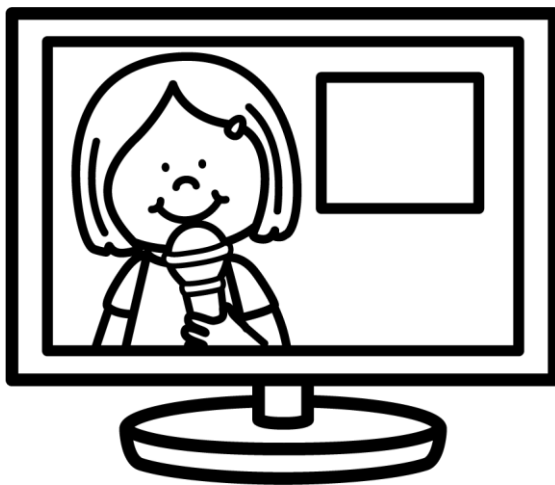

nuacht

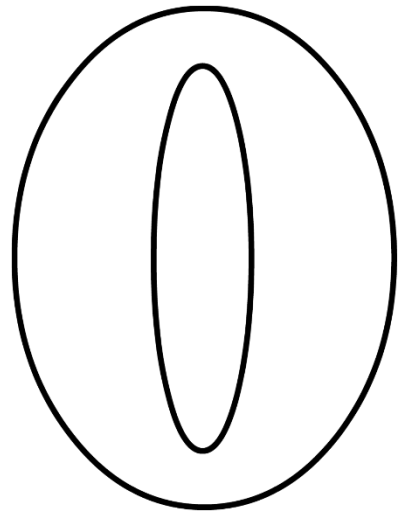

náid

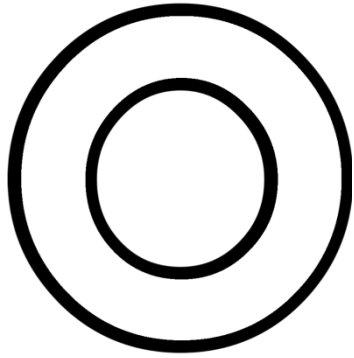

Dathaigh na pictiúir,  
scríobh na focail

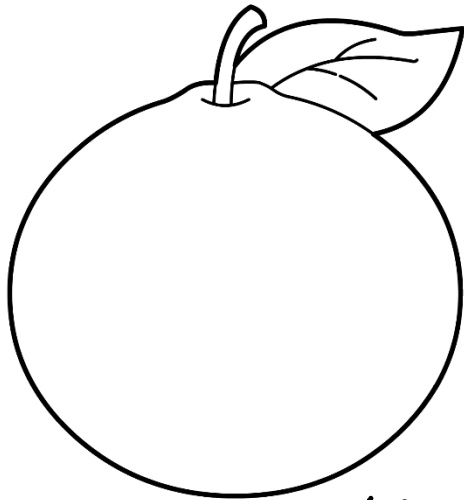

oráiste

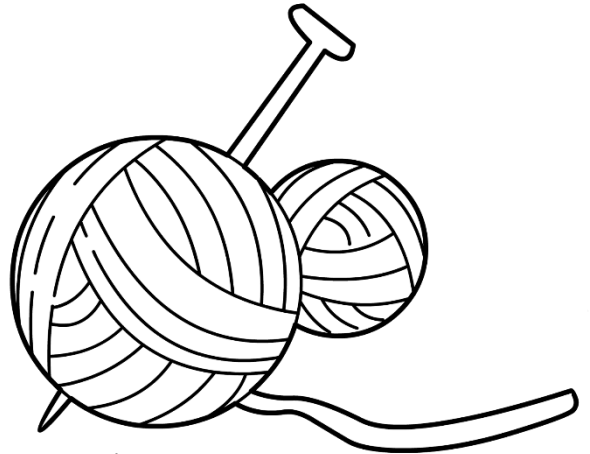

olann

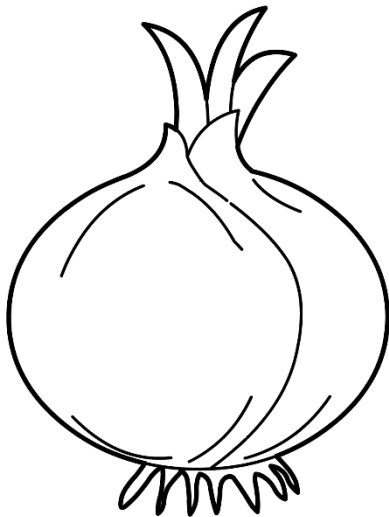

oinniún

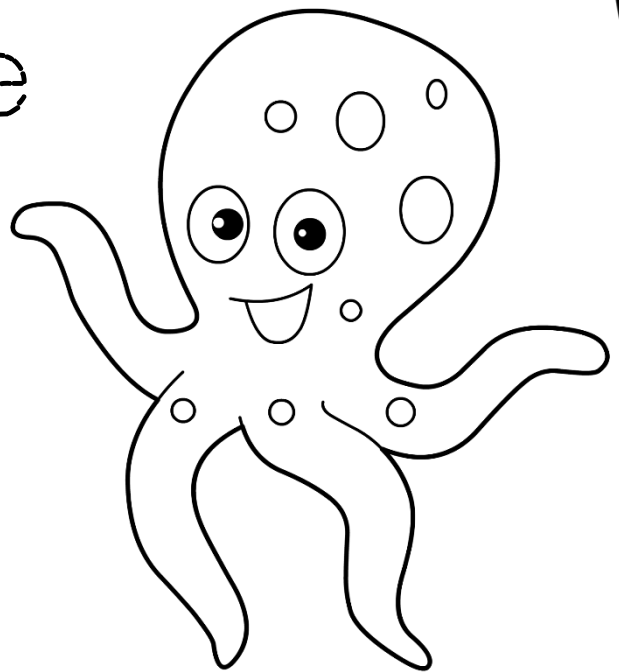

ochtapas

Dathaigh na pictiúir,  
scríobh na focail

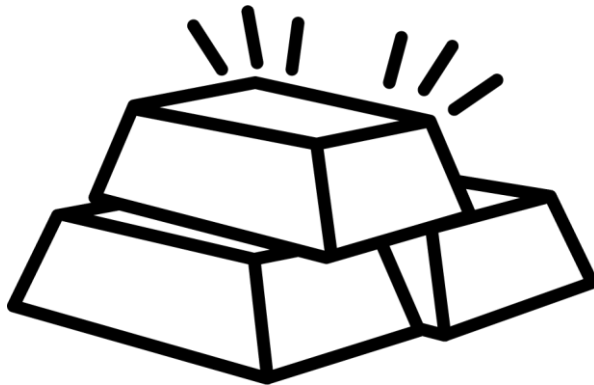
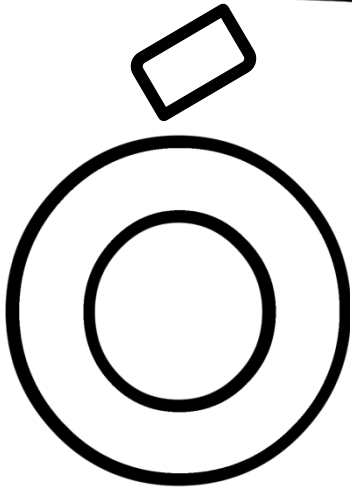

ór

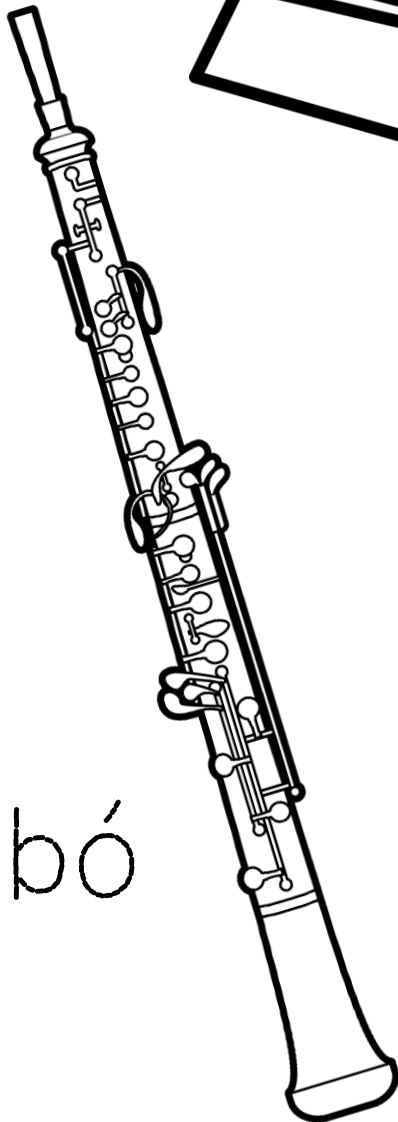

óbó

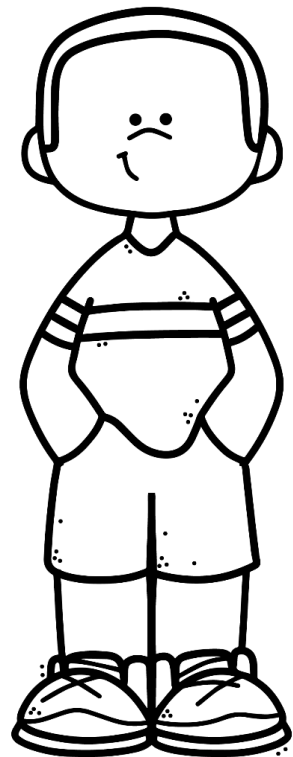

ógfhear

# P

Dathaigh na pictiúir,  
scríobh na focail

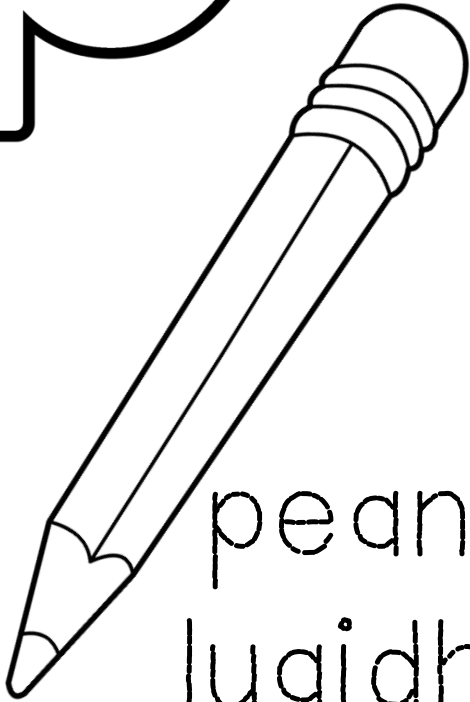

peann  
luaidhe

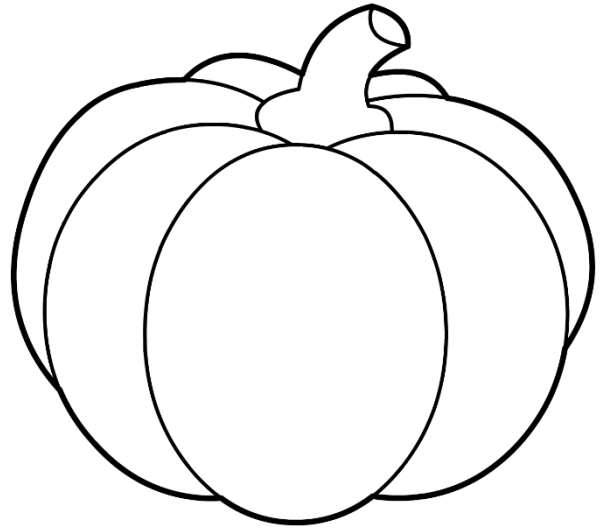

puimcín

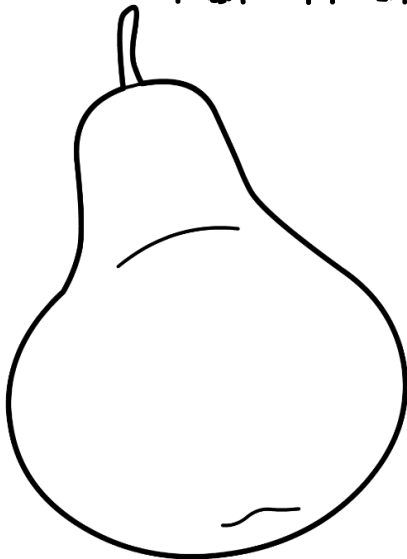

piorra

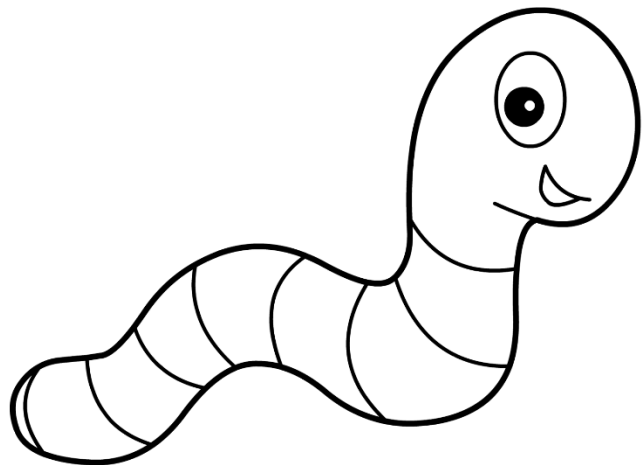

péist

# R

Dathaigh na pictiúir,  
scríobh na focail

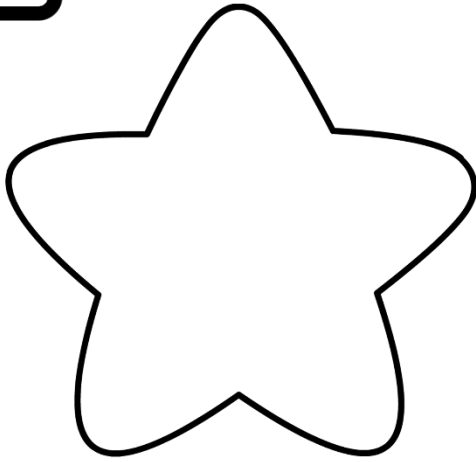

réalta

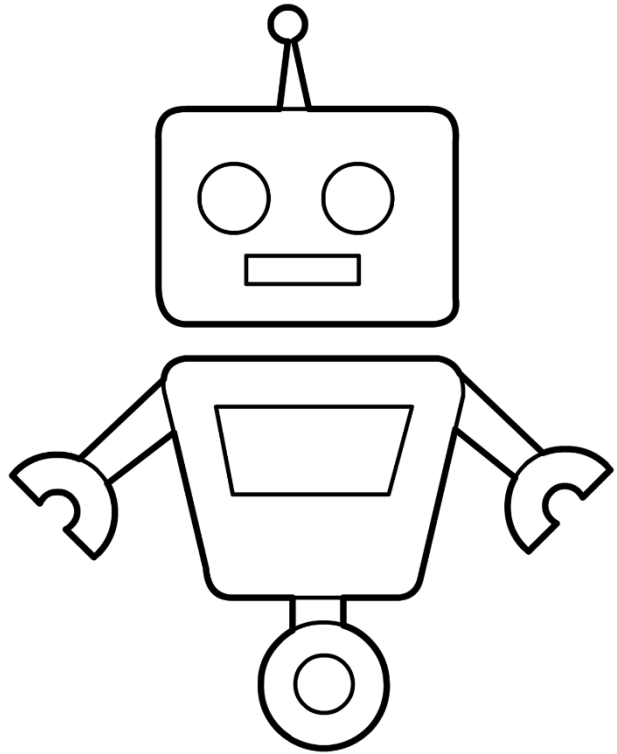

róbat

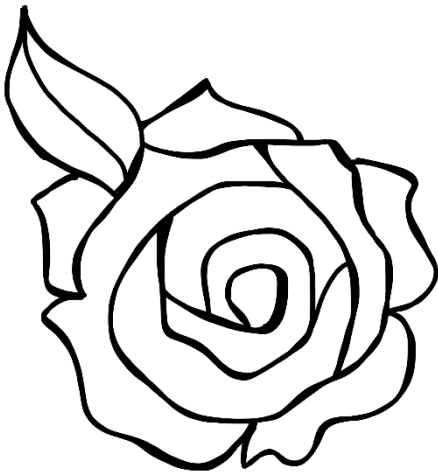

rós

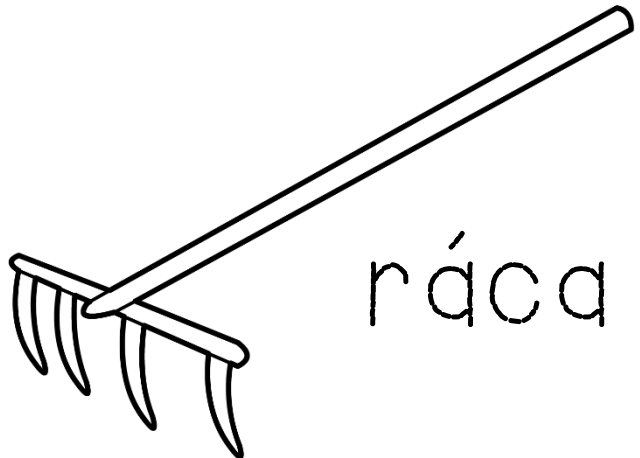

ráca

# S

Dathaigh na pictiúir,  
scríobh na focail

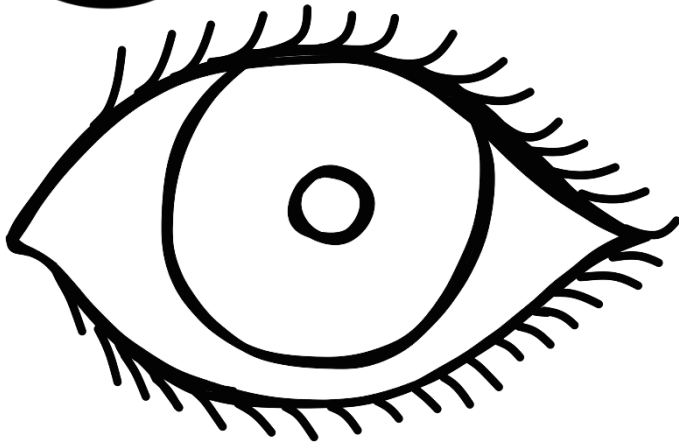

súil

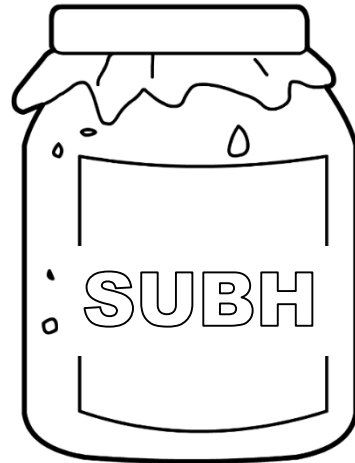

subh



sióg

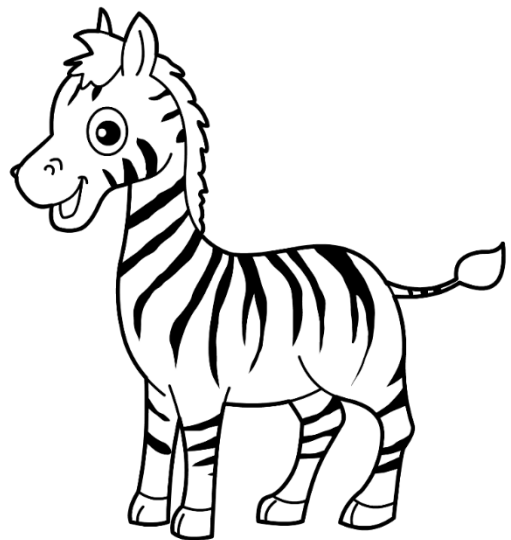

séabra

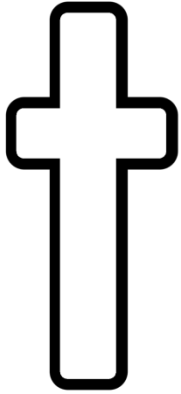

Dathaigh na pictiúir,  
scríobh na focail

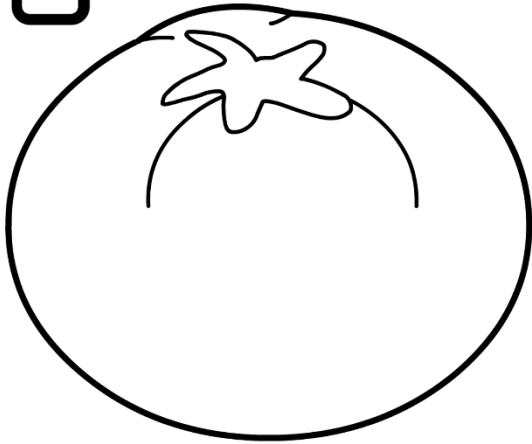

tráta

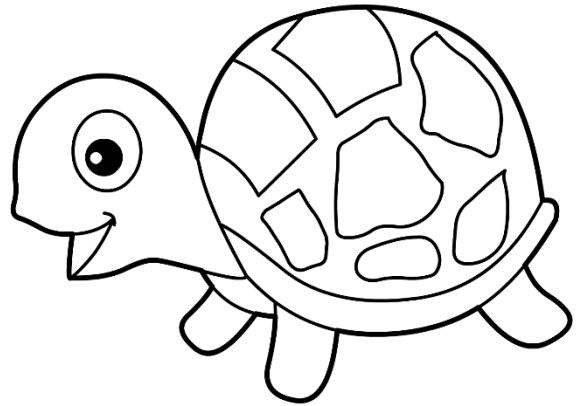

turtar

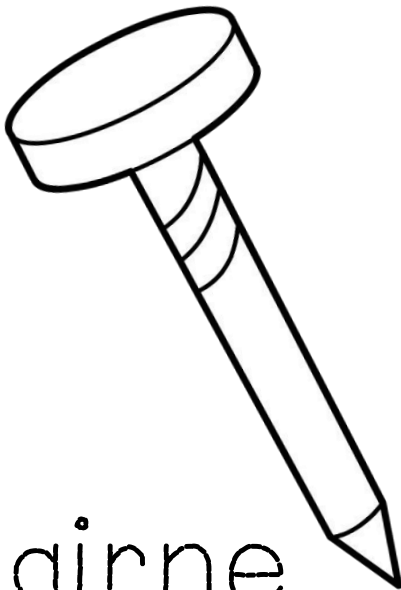

tairne



teach

# U

Dathaigh na pictiúir,  
scríobh na focail

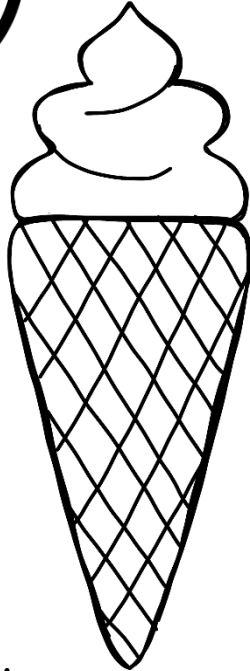

uacht ar  
reoite

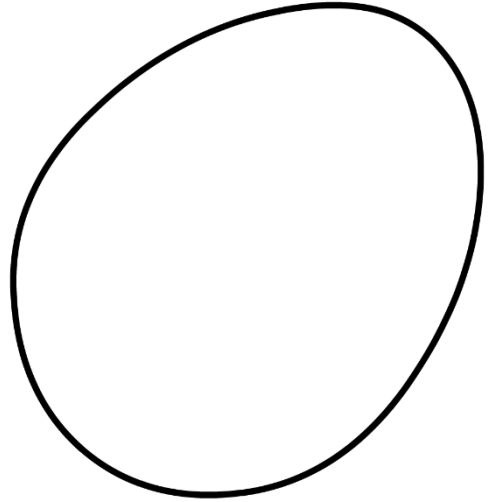

ubh

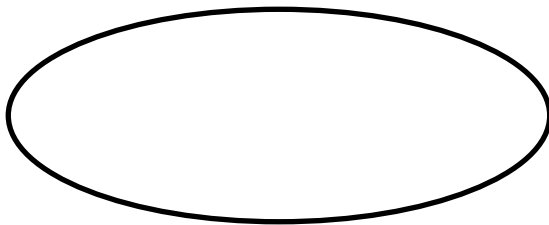

ubhchruth

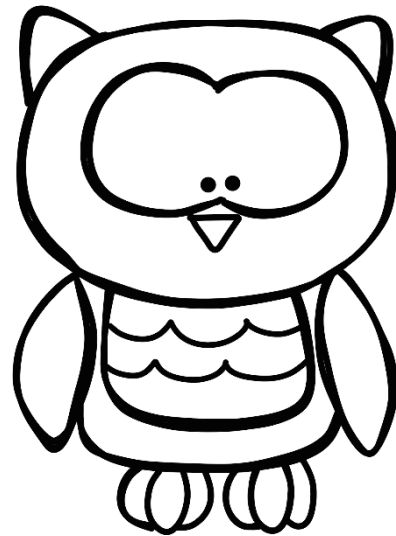

ulchabhán



Ú

Dathaigh na pictiúir,  
scríobh na focail

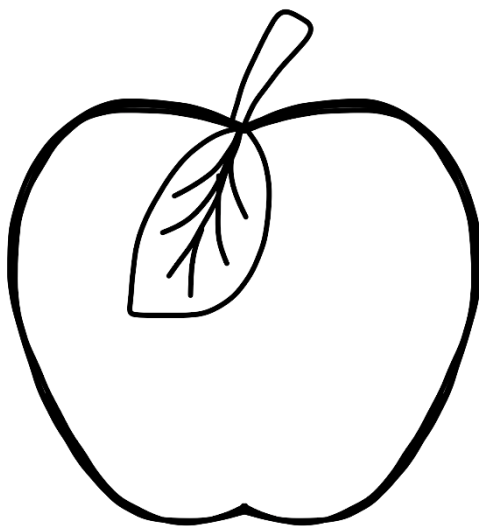

úll



údar

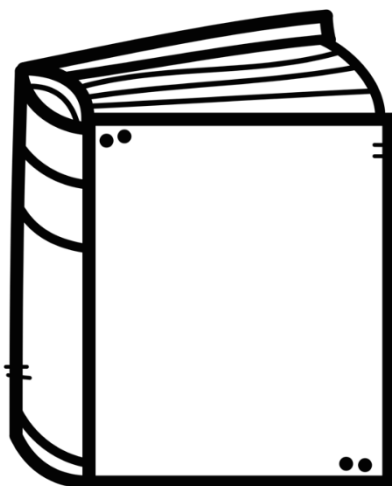

úrscéal

# V

Dathaigh na pictiúir,  
scríobh na focail

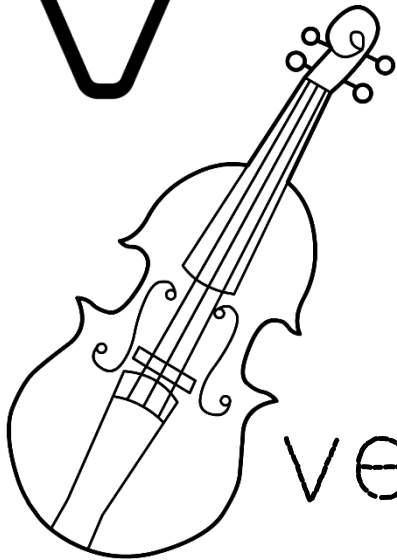

veidhlín

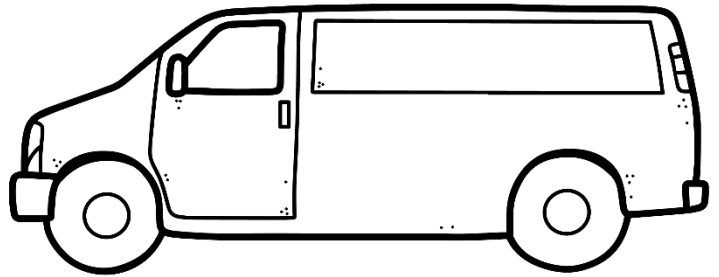

veain



váimpír

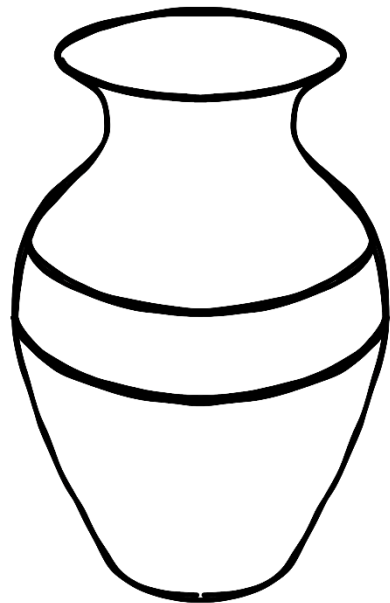

vása

# X

Dathaigh na pictiúir,  
scríobh na focail

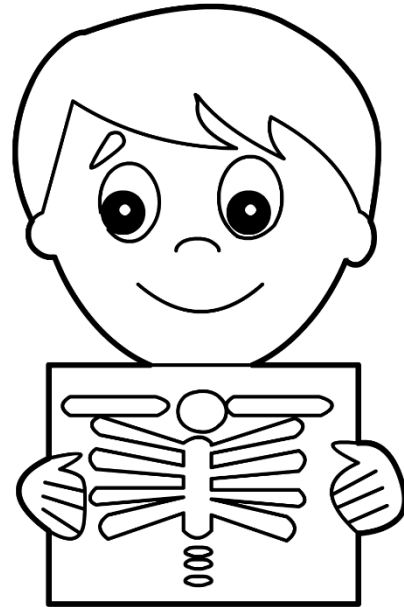

x-ghathú

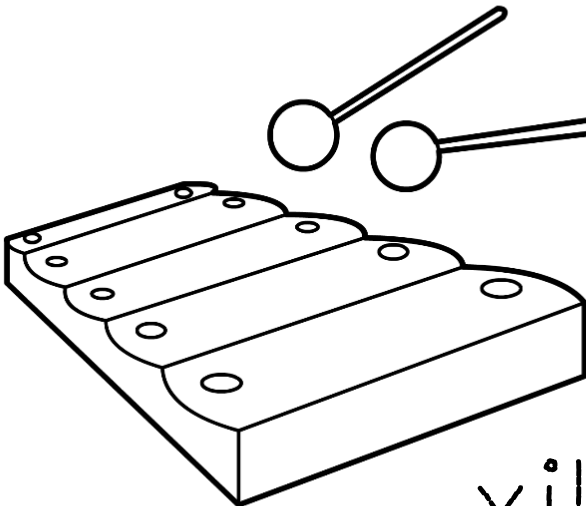

xileafón

# Y

Dathaigh na pictiúir,  
scríobh na focail

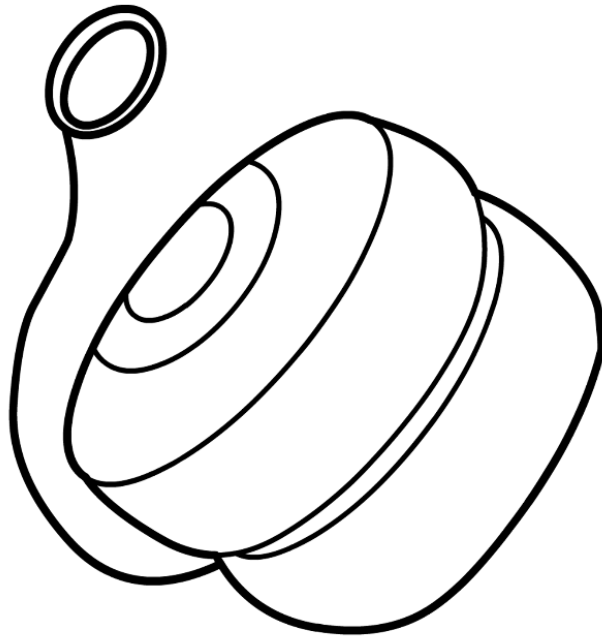

yó-yó

# Z

Dathaigh na pictiúir,  
scríobh na focail

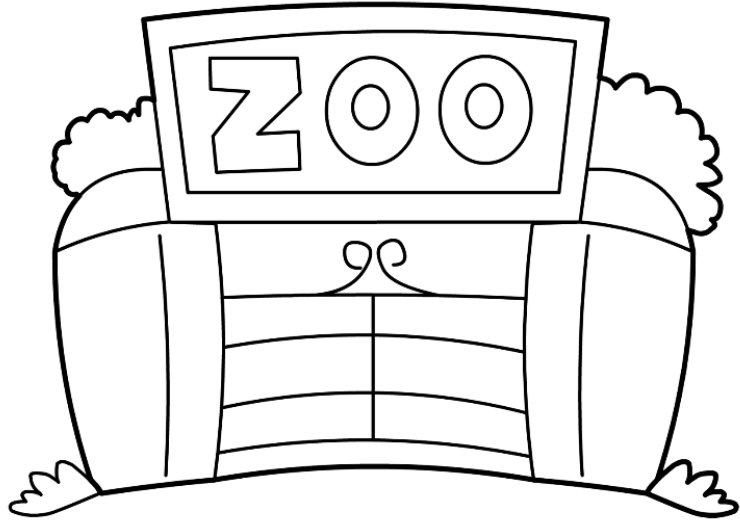

zú

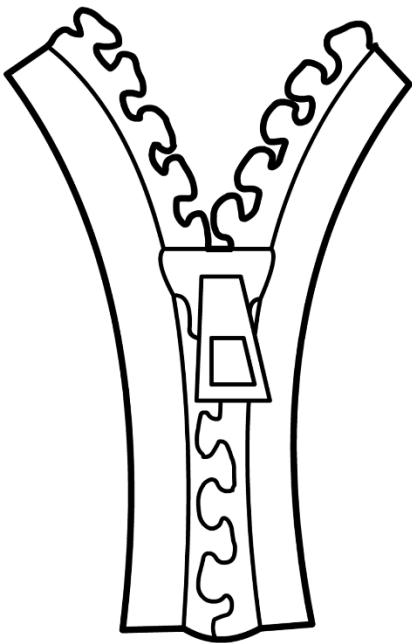

zip

## For Your Information

Thank you for downloading this Seomra Ranga resource. We hope that you find it practical and useful in your classroom.

Please be aware of the following conditions before using this resource.

### Please DO:

- Print and copy this resource so that you can use it with your pupils.
- Make this resource available to your pupils in a private enclosed online space eg. Google Classroom, Seesaw, Edublogs etc.
- Tell others if you have found it useful.

### Please DO NOT:

- Copy or share this resource (in part or whole) with others who have not joined our website. By becoming a member for themselves, they will help the site develop into the future.
- Make this resource available on your school website for anyone to download.
- Share this resource with participants on any sort of course
- Share this resource with other teachers in online groups eg. Facebook Groups, WhatsApp Groups etc.

Kind regards, Seomra Ranga

# Resources used in this file from:



<https://www.teacherspayteachers.com/store/victoria-saied>



<https://www.teacherspayteachers.com/store/educlips>



<https://www.teacherspayteachers.com/store/hello-literacy>



<https://www.teacherspayteachers.com/Store/Palace-Pics>



<https://www.teacherspayteachers.com/Store/Whimsy-Clips>



<https://www.teacherspayteachers.com/Store/Clipartino>



<https://www.teacherspayteachers.com/Store/Krista-Walden-Creative-Clips>



<https://www.teacherspayteachers.com/Store/Whimsy-Workshop-Teaching>

## Resources used in this file from:



<https://www.teacherspayteachers.com/Store/Dancing-Crayon-Designs>